

TIE-27: Stress in optical glass

0. Introduction

The amount and distribution of permanent inherent stress in glass depends on the annealing conditions, the glass type, size and geometry of the glass part. This stress causes birefringence. The amount of birefringence depends on the stress optical coefficient of the glass type. SCHOTT has developed processes to ensure that stress birefringence within optical raw glass is as low as it is needed for the application.

This technical information gives an overview about the generation of mechanical stress in glass, the definition and measurement of stress birefringence, the significance in application and the SCHOTT specification of stress birefringence.

1. The generation of mechanical stress in glass

There are two main reasons for mechanical stress inside a glass part. Mechanical stress can be generated due to the annealing process and due to variations in chemical composition within a melt. Chemical inhomogeneities can lead to local variations of the thermal expansion coefficient and therefore to permanent mechanical stress. Variations in chemical composition within the optical glass are kept on such a low level by homogenization of the melt before casting that the contribution to the generation of mechanical stress can be neglected.

1.1. The generation of mechanical stress during annealing

After melting and casting the glass is cooled down for the first time. This initial coarse annealing is relatively fast and generates mechanical stress inside the glass, which may be too high for further processing like e.g. cutting. Therefore the mechanical stress inside the glass has to be reduced in a fine annealing step.

During this annealing process the glass will be heated to a temperature where the stress in the glass is relieved. For crystals transition from solid to liquid occurs exactly at the melting temperature (T_m). Unlike crystals glass has no fixed melting temperature. Instead it gradually softens and stiffens as the temperature changes. The viscosity of the glass changes with temperature.

Figure 1 shows the viscosity of a glass as a function of temperature. The viscosity curve can be divided into several characteristic sections. The temperatures at which these sections are reached vary from glass to glass.

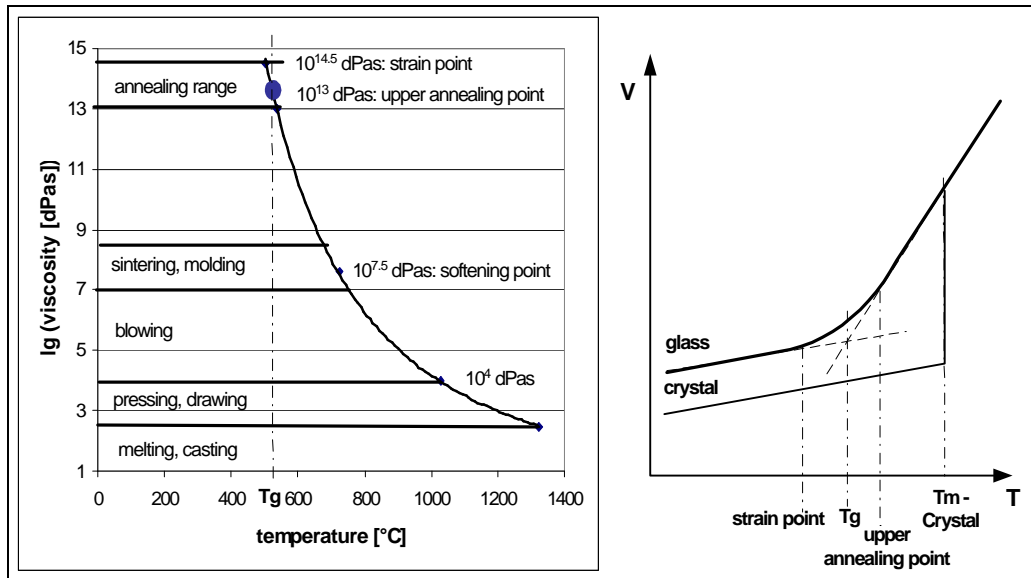

Figure 1: a) The viscosity of glass as a function of temperature. b) Tg definition in a Volume/Temperature diagram

The phase during which the transition from liquid to solid occurs is called the “annealing zone”. The borders of the annealing zone are given by:

- § The upper annealing point: This is the upper end of the annealing zone, where the glass begins to return to liquid state. At this point mechanical stresses inside the glass relax within 15 min.
- § The strain point: This is the lower end of the annealing zone. It’s the temperature where the glass solidifies. The stress (or strain) remaining in the glass at this point is unlikely to be changed or relieved because the glass relaxes in times so long that it can be taken as practically rigid unless it is heated up and annealed again.

The most common temperature definition within the annealing zone is the transformation temperature Tg [1]. The transformation temperature is the temperature at the intersection of the extrapolated slopes in the volume / temperature diagram of the glass (see Figure 1b) and is usually determined by thermal expansion measurement. The viscosity at this point is typically between 10¹³ and 10^{13.6} dPas. Every glass type has its own characteristic transformation temperature. Typical values of Tg lie between 300 and 800°C. N-BK7 for example has a Tg of 557°C.

In principle the stress can be relieved at any temperature within the annealing zone. The lower the viscosity of the glass, the faster the stress relaxes but the more difficult the glass is to handle because it tends to deform under its own weight. Therefore for stress relaxation the glass is normally heated up to temperatures slightly above the transformation temperature.

Figure 2 shows typical annealing temperature curves. In the first step the glass is heated up to a temperature above T_g . After keeping the temperature constant for a certain period of time the fine annealing starts. The glass is then cooled down very slowly to temperatures below T_g . At temperatures far below T_g the cooling rate will be increased. The annealing time strongly depends on the volume / bulkiness of the glass. Large sized glass parts need significantly longer annealing times.

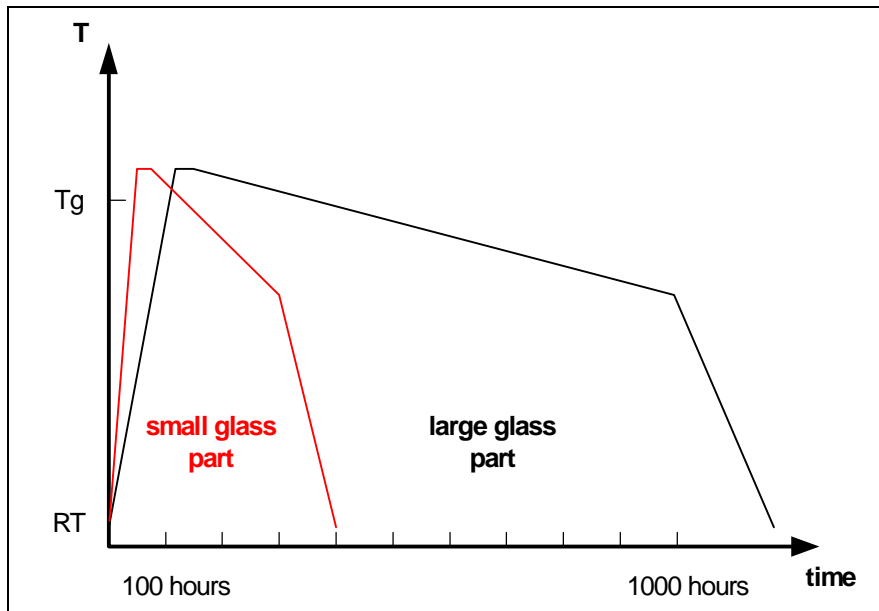

Figure 2: Schematic representation of the annealing temperature as a function of time.

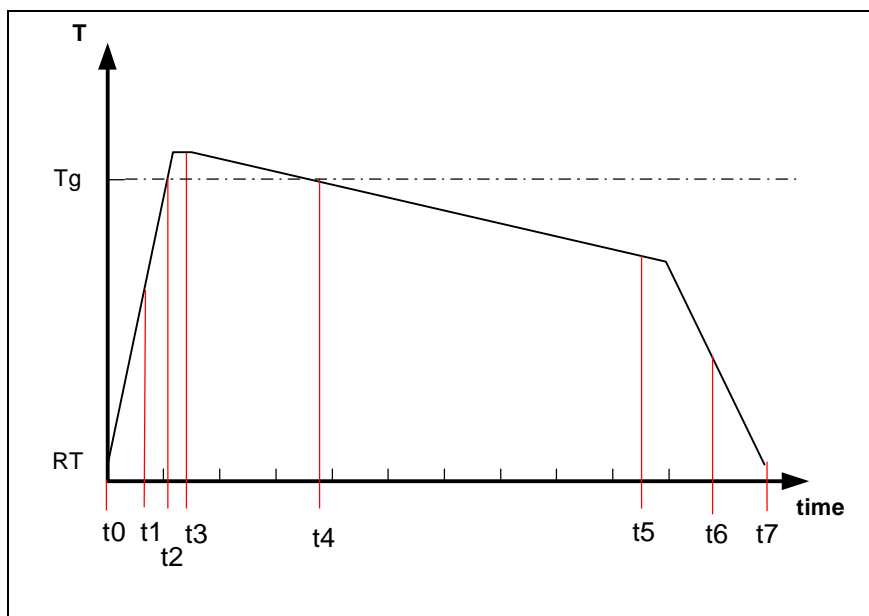

Figure 3: Representative times during a fine annealing cycle.

To get a deeper understanding of what happens at different time during a complete fine annealing cycle (figure 3) a schematic representation of the temperature and stress distribution at different times is given in figures 4 and 5.

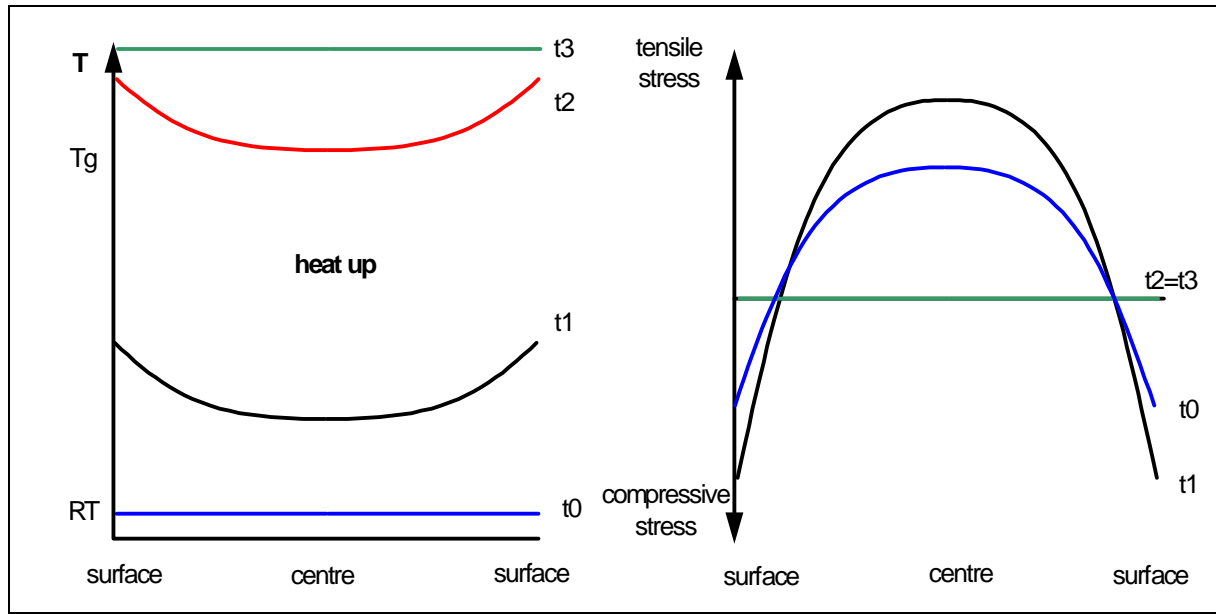

Figure 4: Schematic representation of the stress inside a glass as a function of the temperature distribution after different times for a constant heating rate.

Figure 4 shows what happens during heating up of a glass part with compressive stress according to the temperature program given in figure 3. It was assumed that at room temperature (t_0) the glass part has a stress distribution exhibiting compressive stress at the outer surfaces. The center part of the glass is always at a lower temperature than the outer surfaces during heating because of the low thermal conductivity of glass and the use of economic heating rates. The actual difference of temperature between center part and outer surface depends on the glass type, the geometry of the glass and the annealing rate. With increasing annealing rate and thickness of the glass part the temperature difference in the glass increases. Due to the temperature distribution during heating the compressive stress increases (t_1) until the transformation temperature is reached. At the transformation temperature the glass structure relaxes and becomes completely stress free (t_2). To accelerate the relaxation process and to assure that all glass parts have reached transformation temperature the glass is heated up to temperatures slightly above T_g . This temperature is kept constant for a period of time (t_3) until the temperature in the glass has equalized.

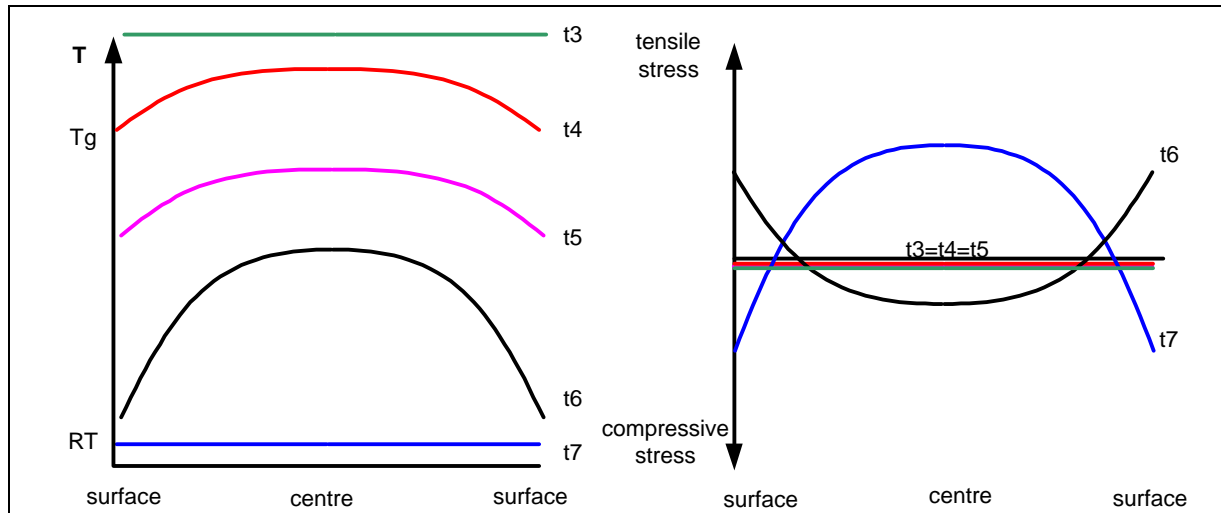

Figure 5: Schematic representation of the stress inside a glass as a function of the temperature distribution after different times during cooling

This cooling phase is the most critical part of the fine annealing (see figure 5). During cooling the glass always loses heat from its surfaces due to convection and radiation. The center part of the glass is always at a higher temperature than the outer surfaces during cooling. Therefore at the beginning of the cooling (t4) a temperature distribution is introduced in the glass that depends on the annealing rate and size of the glass part. The overall glass temperature is still above T_g , therefore the glass remains stress free.

After the glass cools down below T_g it remains in a more or less stress free state as long as the temperature distribution respectively the cooling rate is kept constant (t5). At room temperature the temperature inside the glass equalizes. The center of the glass cools down further while the surface is already at room temperature. Due to the thermal expansion coefficient of the glass the center part of the glass shrinks. The shrinking center part of the glass exhibit compressive stresses to the surface of the glass (t7). The amount of stress introduced therefore depends on the annealing rate, which was applied at the beginning of the cooling process in the area of the annealing zone. In this area annealing rates should be kept as low as possible. After the area has been passed which means below the strain point the inherent permanent mechanical stress is frozen in and cannot be changed regardless of what annealing rate is applied.

In normal practice far below T_g the glass is cooled down to room temperature with a larger annealing rate. The increased annealing rate leads to a steeper temperature distribution (t6). This steeper temperature distribution introduces temporarily tensile stresses that can lead to breakage of the glass part. The cooling rate therefore should not be too high. Nevertheless stresses generated during this phase are only temporarily and vanish after the temperature equalizes within the glass part. The final remaining amount of internal stress and its distribution only depends on the temperature distribution introduced between t3 and t4, which is the time the glass part remained in the annealing zone.

2. Influence of Stress on Refractive Index

2.1. The Photoelastic Coefficients $K_{||}$ und K_{\perp}

Optical isotropic glass becomes anisotropic through mechanical and thermal induced stress. Therefore also the refractive index inside the glass becomes locally anisotropic. Plane polarized waves will be traveling at different velocities through the stressed parts of the glass depending on their polarization direction. For electromagnetic radiation with polarization direction parallel and/or perpendicular to the direction of the mechanical stress the refractive indices are $n_{||} = n_0 + \Delta n_{||}$ and/or $n_{\perp} = n_0 + \Delta n_{\perp}$, whereby n_0 is the refractive index of the isotropic medium. For small mechanical stresses σ , the refractive index changes $\Delta n_{||}$ und Δn_{\perp} are proportional to the mechanical stress σ . The appropriate differential quotients are called the stress optical coefficients:

$$K_{||} = dn_{||}/d\sigma \text{ and } K_{\perp} = dn_{\perp}/d\sigma$$

Common stress optical measurement methods only allow determination of the stress optical birefringence $n_{||} - n_{\perp}$. The actual change in refractive index resulting from permanent and/or temporary stress in the glass can be determined by additional methods (for example, interferometric methods). Figure 5.8 shows the change of the refraction of light in relation to the external compressive and tensile load. High index alkali-lead-silicate glasses (dense flints) display a relatively large absolute change in refractive index with little stress birefringence $n_{||} - n_{\perp}$. Borosilicate glasses (boron crowns) exhibit on the other hand a small absolute change in refractive index with a relatively large stress birefringence $n_{||} - n_{\perp}$.

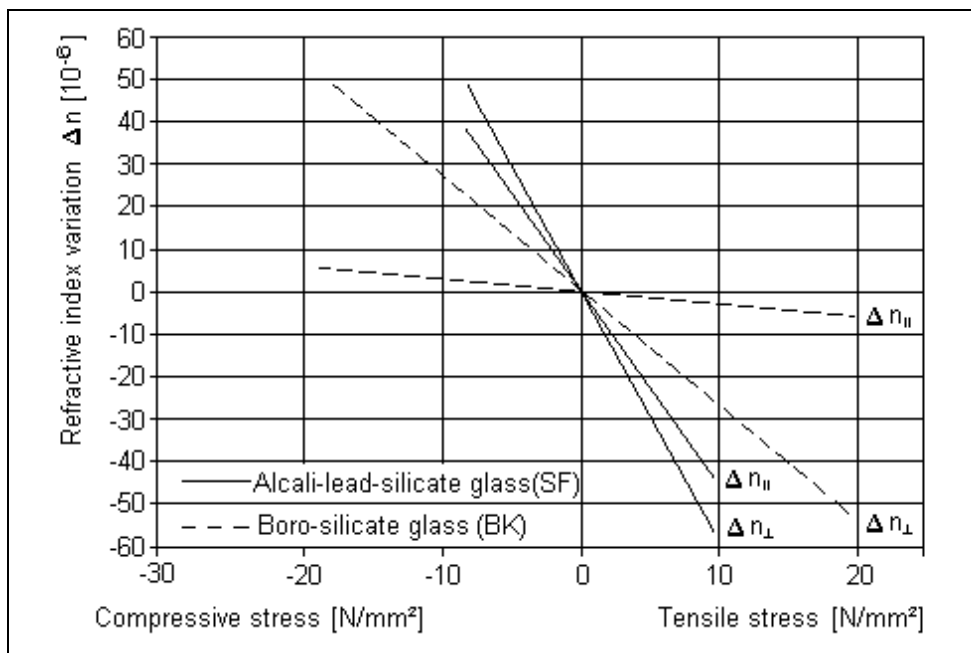

Figure 6: Change in refractive index in relation to external compressive and/or tensile load.

Δn_{\parallel} Change in refractive index for light oscillating parallel to the direction of stress

Δn_{\perp} Change in refractive index for oscillating light perpendicular to the direction of stress

The permanent stresses resulting from the annealing process and the inhomogeneities of refractive index are generally very small. However, if extraordinarily good optical homogeneity is required in large disks and prisms for precision optics, the change in refractive index caused by the small residual stress can be meaningful. The high stresses in thermally strengthened glass sheets, such as those used as windows in high-pressure chambers, causes noticeable changes in refractive index.

In small dimension optical systems the temporary stresses, caused by temperature variations, are mostly negligible. For larger optical systems this temporary stress can be disturbing.

It is important to ensure that optical components are installed in a stress-free manner in their mountings.

2.2 Stress Optical Coefficient K

The stress birefringence can be expressed as the difference in optical path length Δs between two incident plane waves (oscillation planes oriented parallel and perpendicular to the main axis of stress) transmitting the sample of length d at the measurement position. The stress birefringence $n_{\parallel} - n_{\perp}$ is proportional to the effective principal stress difference. The proportionality constant is the stress optical coefficient K . According to the material and wavelength range K can assume positive or negative values.

In a single axis stress state the stress optical coefficient K is defined by the following equation

$$\Delta s = (n_{\parallel} - n_{\perp}) \cdot d = (K_{\parallel} - K_{\perp}) \cdot d \cdot \sigma = K \cdot d \cdot \sigma$$

with:	Δs	Difference in optical path
	d	Light path length in the sample
	n_{\parallel}	Refractive index for oscillating light parallel to the direction of stress
	n_{\perp}	Refractive index for oscillating light perpendicular to the direction of stress
	K_{\parallel}	$(n_{\parallel} - n_0)/\sigma$
	K_{\perp}	$(n_{\perp} - n_0)/\sigma$
	n_0	Refractive index of the unstressed glass
	σ	Mechanical stress (positive for tensile stress)

The unit of the stress optical coefficient K is mm^2N^{-1} , the unit of the stress is Nmm^{-2} or more common MPa.

The stress optical coefficients K are determined at a wavelength of $\lambda = 0.5893 \text{ nm}$ and ambient temperature of 21°C in accordance to the four-edge bending method. The measurement accuracy is $\pm 3\%$ or $\pm 0.06 \cdot 10^{-6} \text{ mm}^2/\text{N}$.

In general the stress optical coefficient is a function of glass type, wavelength and temperature. For most glass types K is nearly constant in the visible range. High lead containing glass like SF glass types show a more pronounced dependence of the stress optical coefficient on the wavelength (see figure 7).

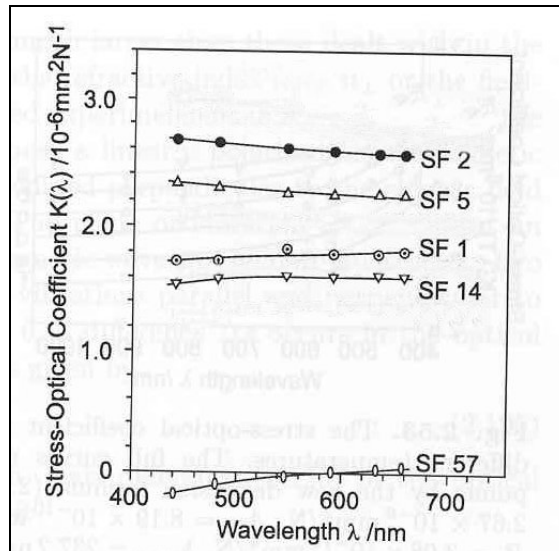

Figure 7: Stress birefringence coefficient for SF glass types as a function of the wavelength [1].

3. Measurement of stress birefringence

The stress birefringence can be visualized by placing the sample between two crossed polarizers. Glass without any stress will appear completely dark. Figure 8 shows a N-BK7 block that was placed between 2 crossed polarizers. The bright areas indicate the internal stress.

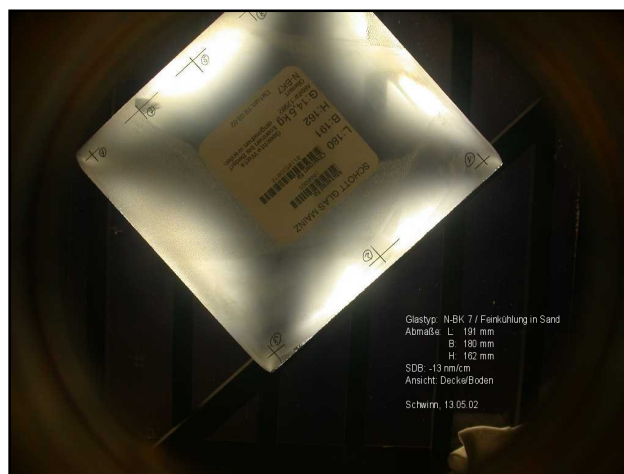

Figure 8: N-BK7 block with internal stress.

Stress birefringence is measured using the de Senarmont and Friedel Method. The birefringence is usually measured at a wavelength of 545 nm (the wavelength of maximum sensitivity of the human eye) using a white light source. The setup is shown in figure 9.

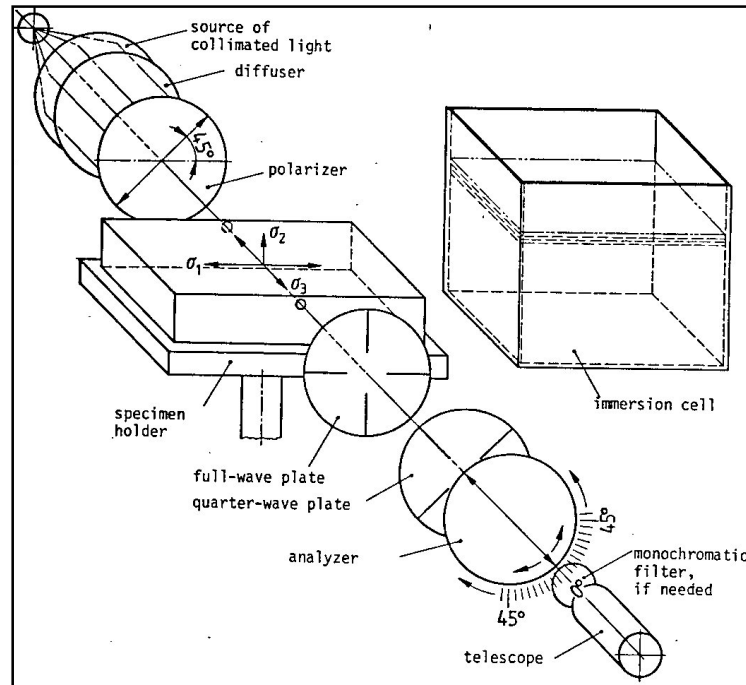

Figure 9: De Senarmont and Friedel experimental setup.

The sample is placed between a polarizer and a quarter wave plate. Behind the quarter wave plate an analyzer is positioned. The direction of the analyzer is oriented perpendicular to the direction of the polarizer. Additionally a full-wave plate can be introduced to determine the sign of the stress. The sample needs to be oriented in such a way that the angle between the polarization direction and the main stress direction is 45°. Areas where the stress is parallel to the direction of the polarizer or analyzer appear dark (the so called isoclinics). This is the reason for the dark cross in figure 8. A detailed description of the theoretical background can be found in [3]

The accuracy of the method is 3-5 nm for simple geometric test sample forms. The measurement is done on round discs at a distance of 5% of the diameter from the edge. For rectangular plates the measurement is performed at the center of the longer side at a distance of 5% of the plate width. The reason for this measurement position is that the maximum stress is always near the edge. Additionally the stress component perpendicular to the edge vanishes and therefore makes the interpretation of the measurement results easier.

A detailed description of this method can be found in ISO 11455 [4]

The measurement can also be done at any other wavelength depending on the specific circumstances. Sometimes it is more convenient and accuracy increasing to use monochromatic light for the measurement. For such cases we use a low-pressure sodium lamp with light at 589 nm wavelength. Another example is the stress measurement of SF57.

The measurement takes place at 440 nm because the stress optical coefficient is about ten times higher at this wavelength. More information about stress measurement of SF57 can be found in [5].

Other commercially available test equipments use other wavelengths (e.g. He-Ne Laser based equipment with wavelength of ~633 nm).

The de Senarmont and Friedel Method is insufficient for measurement of low stress birefringence and low thickness. In these cases we have alternative methods to measure an order of magnitude more accurately.

4. Significance of stress birefringence in application

Stress birefringence inside a glass leads to difference in refractive index for light beams with different polarization directions. Stress birefringence inside a lens therefore leads to different focal lengths depending on the polarization of the incident light. Therefore the picture becomes blurred. The ISO 10110 part 2 [6] gives examples of permissible stress birefringence values for typical applications (see table 1):

Permissible optical path difference per cm glass path	Typical applications
< 2 nm/cm	Polarization instruments Interference instruments
5 nm/cm	Precision optics Astronomical optics
10 nm/cm	Photographic optics Microscope optics
20 nm/cm	Magnifying glasses
Without requirement	Illumination optics

Table. 1: Permissible stress birefringence values for some typical applications.

5. Minimum stress

To achieve a minimum of mechanical stress in optical glass it is necessary to subject it to a fine annealing with ideally crossing the strain point as slow as possible. In reality this is often not feasible due to two main reasons: First it is uneconomical because very small annealing rates increase the overall annealing time and therefore the cost of the glass. The second reason is that the annealing rate also influences the refractive index of the glass.

For most glasses the refractive index increases with decreasing annealing rate. This effect is used to adjust the refractive index of optical glasses after coarse annealing into the specified tolerance range. Therefore the need of stress free glasses often may prevent to meet a specific refractive index range for a given melt.

The minimum achievable stress within a glass does not only depend on the proper annealing rate but also on the glass type and the production process. In general the internal stress is a function of the volume and bulkiness: The smaller or the thinner the glass is, the smaller the temperature differences and the smaller the generated stress during annealing will be. On the other hand this also means that for very large glass blank the annealing time needs to be much longer. Therefore to achieve very low stress birefringence in very large glass parts (>600 mm) may lead to annealing times beyond reasonable limits [7].

It is also important to know that cutting a stressed glass part into smaller pieces will reduce the internal stress. Figure 10 shows the effect of cutting a stressed N-BK7 glass block into smaller parts. The maximum stress birefringence was measured after every cut. It can be clearly seen that in this case the first cut reduces the internal stress of the glass by more than a factor of two.

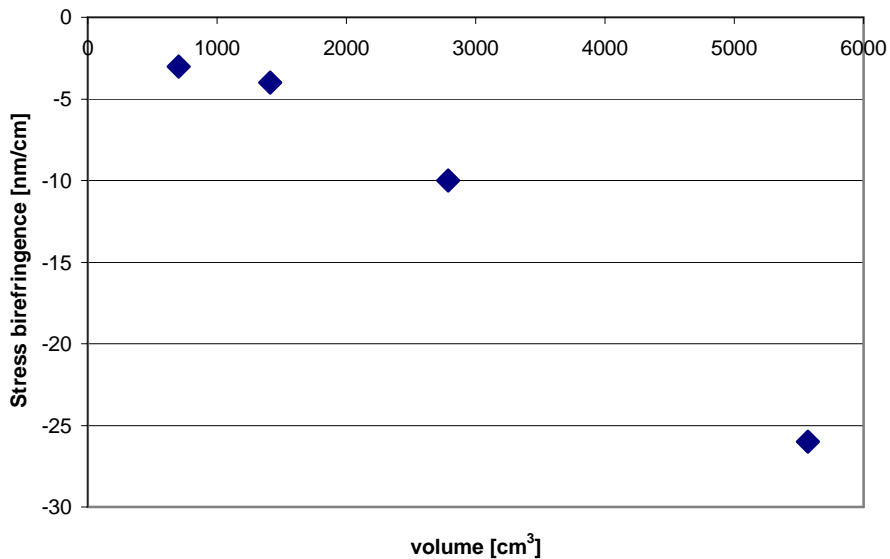

Figure 10: Stress birefringence reduced by cutting a N-BK7 glass block.

This very rough correlation between the maximum stress birefringence and the volume of the glass part is only valid down to a maximum stress birefringence of ~2 nm/cm. Below this limit other anisotropy effects may not be negligible anymore.

6. SCHOTT specification of stress birefringence

Table 2 shows the limit values for stress birefringence in processed glasses for various dimensions.

Sizes	Stress Birefringence		
	fine annealing [nm/cm]	special annealing (SK) [nm/cm]	special annealing (SSK) [nm/cm]
Ø: ≤ 300 mm d: ≤ 60 mm	≤ 10	≤ 6	≤ 4
Ø: > 300 - 600 mm d: > 60 - 80 mm	≤ 12	≤ 6	≤ 4

Table 2: Limit values of stress birefringence in processed glasses for various dimensions.

The typical stress birefringence of a fine annealed piece block glass that has been cut to a thickness of about 100 mm is ≤ 10 nm/cm (assumed size 160x160x100 mm).

With our annealing methods we are able to achieve both good optical homogeneity and very low stress birefringence values. Pieces of glass to be delivered generally have a symmetrical stress distribution. The glass surface is usually in compression.

As mentioned before cutting the raw glass in smaller parts generally reduces the stress birefringence. If the final optical elements are much smaller than the raw glass format they have been cut from the remaining stress birefringence will be in most cases far below the limit values given in table 2.

The limit value for stress birefringence in parts larger than 600 mm are available upon request. Higher stresses are permitted in glass to be hot processed, but they may not limit mechanical processing.

7. Literature

- [1] ISO 7884-8; Glass – Viscosity and viscometric fixed points – Part 8: Determination of (dilatometric) transformation temperature, 1987
- [2] The properties of optical glass; H. Bach & N. Neuroth (Editors), Springer Verlag 1998
- [3] Basic Optical Stress Measurement in Glass; H. W. Mc Kenzie & R. J. Hand, Society of Glass Technology 1999
- [4] ISO 11455; Raw optical glass -- Determination of birefringence; 1995
- [5] SCHOTT Technical Information TNE7 Stress measurement of SF57
- [6] ISO/DIS 10110 - part 2; Preparation of drawings for optical elements and systems; Material Imperfections – Stress birefringence, 1996
- [7] Optical glasses and glass ceramics for large optical systems; Thorsten Döhring, Peter Hartmann, Hans F. Morian, Ralf Jedamzik, Proceedings of SPIE -- Volume 4842, February 2003, pp. 56-66

For more information please contact:

Advanced Optics

SCHOTT AG

Germany

Phone: + 49 (0) 6131/66-1812

Fax: + 49 (0) 3641/2888-9047

E-mail: info.optics@schott.com

www.schott.com/advanced_optics