

# Halogen Lamps & Modulamp Assemblies

For ACE® and DCR® Series Light Sources



EKE 150 Watt Halogen Lamp, A08120



DDL 150 Watt Halogen Lamp, A08130



Modulamp Assembly, A08301, with lamp socket, A29506



Iris Diaphragm, A08321.2

## 150 Watt Halogen Lamps

Part No.	Type	Description
A08120	EKE	21 V, 3250° K color temperature; high output for most applications; Rated 200 hrs, 2000 hrs w/ a dimmer*
A08130	DDL	20 V, 3150° K color temperature; high output for most applications; Rated 200 hrs, 2000 hrs w/ a dimmer*

\*Voltage reduced to 80% of full intensity

## Product and Performance Characteristics

### Lamp Features

- Use with ACE® Series and DCR® Series light sources
- 150 watt tungsten halogen bulbs: EKE and DDL types available
- The correct lamp for your light source is specified on the label located on the front of the Modulamp Unit

### Modulamp Assembly Features

- Assures maximum light delivery to fiber optic components
- Use with all ACE® Series and DCR® Series light sources
- Full illumination on .60" (15 mm) active diameter input
- Interchangeable Modulamp Units offer 2 lamp positions to maximize individual lamp efficiencies
- Choice of two, 150 watt halogen lamps - EKE, DDL
- IR interference filter for cool illumination
- Iris version also available (made-to-order)

## Modulamp Assembly - Standard without Lamp

Part No.	Description
A08301	Lamp holder for EKE lamp
A08301.2	Lamp holder for DDL lamp

## Modulamp Assembly – in Diaphragm without Lamp

Part No.	Description
A08321	Lamp holder for EKE lamp
A08321.2	Lamp holder for DDL lamp

## Lamp Socket

Part No.	Description
A29506	Lamp Socket for ACE® and DCR® series light sources.



Version 02.2017



## Lamp Specifications

Bulb type	EKE	DDL
Voltage	21	20
Wattage	150	150
Lamp Base	GX5.3	GX5.3
Bulb Finish	Clear	Clear
Burn Position	Base/ Down Horiz.	Base/ Down Horiz.
Shape	MR-16	MR-16
Color Temp	3250	3150
Filament	CC-6	CC-6
Lamp Fill	Halogen	Halogen
Lamp Life	200 Hours	500 Hours
Overall Length (mm)	44.5	44.5
Reflector Design	Dichroic	Dichroic
Reflector Size (mm)	50.7	50.7
Working distance (mm)	44.5	194.5

## Lamp Intensity vs. Time

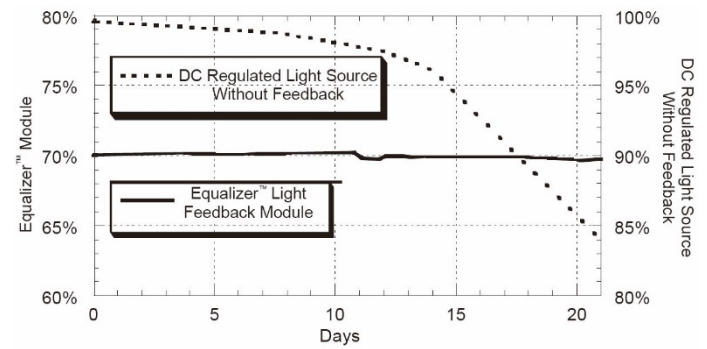

## A08301, A08301.2 Modulamp Assembly

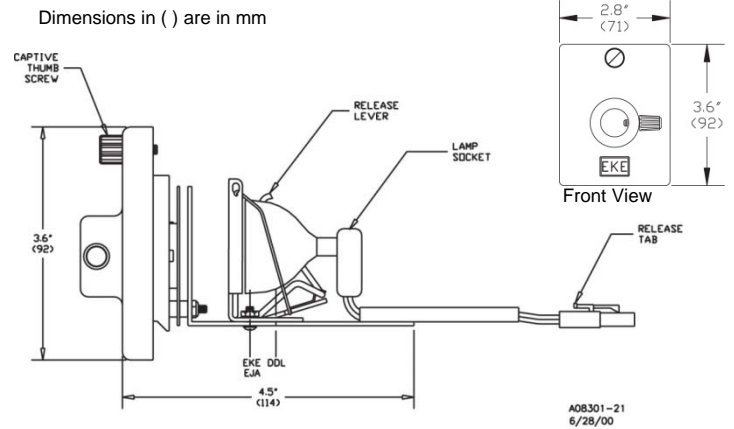

## A08120 & A08130 – Lamp Beam Patterns

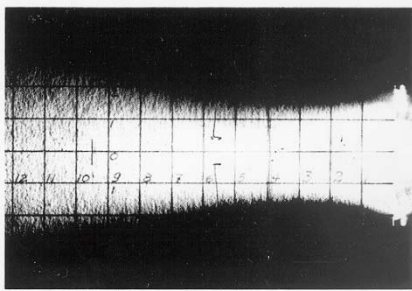

DDL 20V, 150W  
MICROFILM PROJECTION

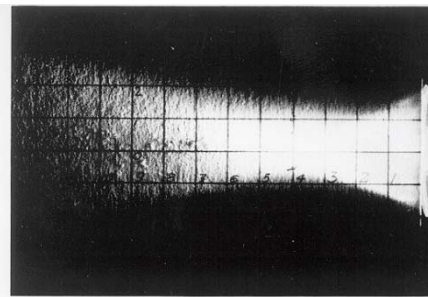

EKE 21V, 150W  
8MM PROJECTION

## Spectral Curves w/Interference IR Filter

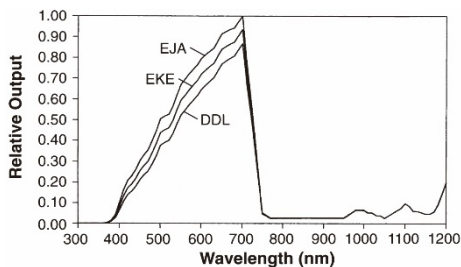

## Color temperature Change vs. Lamp Intensity

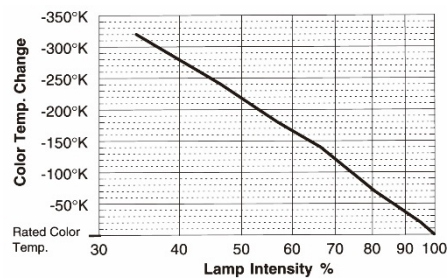

## Lamp Intensity vs. Intensity Control Knob Setting

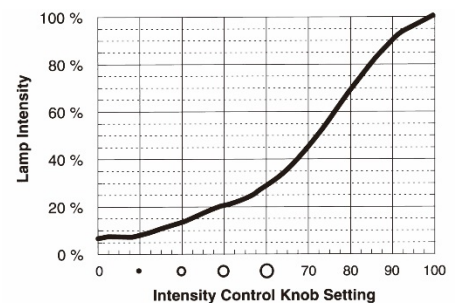

All specifications are subject to change without prior notice. This datasheet or any extracts thereof may only be used in other publications with express permission of SCHOTT. © SCHOTT North America, Inc.

Lighting and Imaging  
**SCHOTT North America, Inc.**  
 122 Charlton Street  
 Southbridge, MA 01550  
 USA  
 Phone: +1 (508) 765-9744  
 Fax: +1 (508) 765-1299  
 lightingimaging@us.schott.com  
 www.us.schott.com/lightingimaging

**SCHOTT**  
 glass made of ideas